

DEHUMIDIFIER



turn to the experts™ 

OWNER'S MANUAL



CDG-205E
CDG-255E
CDG-305E



Before operating this product, please read the instructions carefully and save this manual for future use.

CONTENTS

SAFETY PRECAUTIONS

Warning	2
Caution	2
Electrical information	3

CONTROL PADS ON THE DEHUMIDIFIER

Control pads.....	4
Other features.....	5

IDENTIFICATION OF PARTS

Identification of parts	6
Positioning the unit	7

OPERATING THE UNIT

When using the unit	7
Removing the collected water	8

CARE AND MAINTENANCE

Care and cleaning of the dehumidifier	9
---	---



TROUBLESHOOTING TIPS

Troubleshooting tips	10
----------------------------	----



SAFETY PRECAUTIONS

To prevent injury to the user or other people and property damage, the following instructions must be followed. Incorrect operation due to ignoring of instructions may cause harm or damage.

- The seriousness is classified by the following indications.

 WARNING	This symbol indicates the possibility of death or serious injury.
 CAUTION	This symbol indicates the possibility of injury or damage to property.

- Meanings of symbols used in this manual are as shown below.

	Never do this.
	Always do this.

WARNING

⊘ Do not exceed the rating of the power outlet or connection device.

- Otherwise, it may cause electric shock or fire due to excess heat generation.

⊘ Do not operate or stop the unit by switching on or off the power.

- It may cause electric shock or fire due to heat generation.

⊘ Do not damage or use an unspecified power cord.

- It may cause electric shock or fire.

⊘ Do not modify power cord length or share the outlet with other appliances

- It may cause electric shock or fire due to heat generation.

⊘ Do not insert or pull out plug with wet hands.

- It may cause electric shock.

⊘ Do not place the unit near a heat source.

- Plastic parts may melt and cause a fire.

⊘ Disconnect the power if strange sounds, smell, or smoke comes from it.

- It may cause fire and electric shock.

⊘ You should never try to take apart or repair the unit by yourself.

- It may cause failure of machine or electric shock.

⊘ Before cleaning, turn off the power and unplug the unit.

- It may cause electrical shock or injury.

⊘ Do not use the machine near flammable gas or combustibles, such as gasoline, benzene, thinner, etc.

- It may cause an explosion or fire.

⊘ Do not drink or use the water drained from the unit.

- It contains contaminants and could make you sick.

⊘ Do not take the water bucket out during operation.

- It may cause bucket full protect of the unit and cause electric shock.

CAUTION

⊘ Do not use the unit in small spaces.

- Lack of ventilation can cause overheating and fire.

⊘ Do not put in places where water may splash onto the unit.

- Water may enter the unit and degrade the insulation. It may cause an electric shock or fire.

⊘ Place the unit on a level, sturdy section of the floor.

- If the unit falls over, it may cause water to spill and damage belongings, or cause electrical shock or fire.

SAFETY PRECAUTIONS

CAUTION

⊘ Do not cover the intake or exhaust openings with cloths or towels.

- A lack of air flow can lead to overheating and fire.

⊘ Care should be taken when using the unit in a room with the following persons:

- Infants, children, elderly people, and people not sensitive to humidity.

⊘ Do not use in areas where chemicals are handled.

- This will cause the unit deterioration due to chemicals and solvents dissolved in the air.

⊘ Never insert your finger or other foreign objects into grills or openings. Take special care to warn children of these dangers.

- It may cause electric shock or failure of appliance.

⊘ Do not place heavy object on the power cord and take care so that the cord is not compressed.

- There is danger of fire or electric shock.

⊘ Do not climb up on or sit on the unit.

- You may be injured if you fall or if the unit falls over.

⊘ Always insert the filters securely. Clean filter once every two weeks.

- Operation without filters may cause failure.

⊘ If water enters the unit, turn the unit off and disconnect the power, contact a qualified service technician.

- It may cause failure of appliance or accident.

⊘ Do not place flower vases or other water container on top of the unit.

- Water may spill inside the unit, causing insulation failure and electrical shock or fire.

Electrical Information

- The manufacturer's nameplate is located on the rear panel of the unit and contains electrical and other technical data specific to this unit.
- Be sure the unit is properly grounded. To minimize shock and fire hazards, proper grounding is important. The power cord is equipped with a three-prong grounding plug for protection against shock hazards.
- Your unit must be used in a properly grounded wall receptacle. If the wall receptacle you intend to use is not adequately grounded or protected by a time delay fuse or circuit breaker, have a qualified electrician install the proper receptacle.
- Ensure the receptacle is accessible after the unit installation.
- Do not use extension cords or an adapter plugs with this unit.** However, if it is necessary to use an extension cord, use an approved "Dehumidifier" extension cord only (available at most local hardware stores).
- To avoid the possibility of personal injury, always disconnect the power supply to the unit, before installing and/or servicing.

CONTROL PADS ON THE DEHUMIDIFIER

NOTE: The control panel of the unit you purchased may be slightly different according to the models.

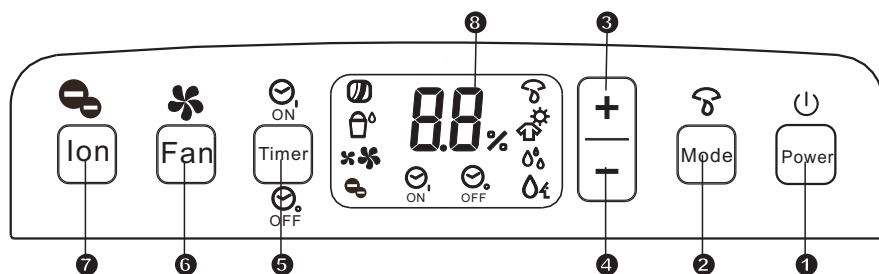

Fig. 1

Control pads

When you push the pad to change operation modes, the unit will make a beep sound to indicate that it is changing modes and the corresponding indicators in Display Window illuminate.

1 Power Pad

Press to turn the dehumidifier on and off.

2 Mode Pad

Press to select the desired operation mode from Dehumidifying, Dryer, Continuous dehumidifying and Smart dehumidifying.

NOTE: Dryer and Smart dehumidifying modes are optional.

3 4 +/− : Down/Up Pads

● Humidity Set Control Pads

The humidity level can be set within a range of 35%RH(Relative Humidity) to 85%RH(Relative Humidity) in 5% increments.

For drier air, press the ⊖ pad and set to a lower percent value(%).

For damper air, press the ⊕ pad and set a higher percent value(%).

● TIMER Set Control Pads

Use the Up/Down pads to set the Auto start and Auto stop time from 0.0 to 24.

5 Timer Pad

Press to initiate the Auto start and Auto stop feature, in conjunction with the ⊕ and ⊖ key pads.

6 Fan Pad

Control the fan speed. Press to select either High or Normal fan speed. Set the fan control to High for maximum moisture removal. When the humidity has been reduced and quiet operation is preferred, set the fan control to Normal.

7 Ion Pad(optional)

Press to activate the ionizer. Anions are automatically generated by ionization. The anions deactivate the airborne chemical vapors and dust particles. Press it again to stop the function.

NOTE: When the Display Window is dark, first press any Pads (except the Power Pad) to make the Display Window light, press again to set desired operation modes.

8 Display Window

Shows the set % humidity level from 35% to 85% or auto start/stop time (0~24) while setting, then shows the actual(± 5% accuracy) room % humidity level in a range of 30%RH(Relative Humidity) to 90%RH (Relative Humidity).

Error Codes and Protection Codes:

AS- Humidity sensor error--Unplug the unit and plug it back in. If error repeats, call for service.

ES- Temperature sensor error-- Unplug the unit and plug it back in. If error repeats, call for service.

P1- Unit is defrosting-- Allow the unit time to automatically defrost. The protection will clear after the unit self defrosts.

P2- Bucket is full or bucket is not in right position-- Empty the bucket and replace it in the right position.

E3- Unit malfunction-- Unplug the unit and plug it back in. If error repeats, call for service.

Indicators on Display Window:

-Displays when the Filter operation is on (unavailable on this unit).

-displays when Bucket is full.

-Displays when Normal Fan function is set.

-Displays when High Fan function is set.

CONTROL PADS ON THE DEHUMIDIFIER

-Displays when Ion function is set.

-Displays when Timer ON function is set.

-Displays when Timer OFF function is set.

-Displays when Dehumidifying mode is set.

-Displays when Dryer mode is set.

-Displays when Continuous Dehumidifying mode is set.

-Displays when Smart Dehumidifying mode is set.

Other features

Bucket Full indicator

Glows when the bucket is ready to be emptied, or when the bucket is removed or not replaced in the proper position.

Auto Shut Off

The dehumidifier shuts off when the bucket is full, or when the bucket is removed or not replaced in the proper position. When the setting humidity is reached, the unit will be shut off automatically. For some models, the fan motor will continue operating.

Auto Defrost

When frost builds up on the evaporator coils, the compressor will cycle off and the fan will continue to run until the frost disappears.

NOTE: When Auto defrosting operation, the unit may make a voice of refrigerant flowing, it is normal.

Wait 3 minutes before resuming operation

After the unit has stopped, it can not be restart operation in the first 3 minutes. This is to protect the unit. Operation will automatically start after 3 minutes.

Smart dehumidifying mode(optional)

At smart dehumidifying mode, the unit will automatically control room humidity in a comfortable range 45%~55% according to the room temperature. The humidity setting function will be invalid.

Auto-Restart

If the unit breaks off unexpectedly due to the power cut, it will restart with the previous function setting automatically when the power resumes.

Setting the Timer

- When the unit is on, first press the Timer button, the Timer Off indicator light illuminates. It indicates the Auto Stop program is initiated. Press it again the Time On indicator light illuminates. It indicates the Auto Start is initiated.
- When the unit is off, first press the Timer button, the TIMER ON indicator light illuminates. It indicates the Auto Start program is initiated. Press it again the Time Off indicator light illuminates. It indicates the Auto Stop is initiated.
- Press or hold the UP or DOWN pad to change the Auto time by 0.5 hour increments, up to 10 hours, then at 1 hour increments up to 24 hours. The control will count down the time remaining until start.
- The selected time will register in 5 seconds and the system will automatically revert back to display the previous humidity setting.
- When the Auto start & Auto stop times are set, within the same program sequence, TIMER ON OFF indicator lights illuminate identifying both ON and OFF times are now programmed.
- Turning the unit ON or OFF at any time or adjusting the timer setting to 0.0 will cancel the Auto Start/Stop function.
- When LED display window displays the code of P2, the Auto Start/Stop function will also be cancelled.

IDENTIFICATION OF PARTS

Dryer mode(optional)

The unit can make the MAX dehumidification function when it is under the Dryer mode. The fan speed is fixed at high fan speed. The humidity level is automatically controlled according to the actual room humidity. The unit will quit dryer mode after a maximum 10 hours' operation.

NOTE:

- The Dryer mode must be operated in a close room, do not open the door and window.
- To make the best effective dehumidification, please first dehydrate the wet clothes.
- Make sure to direct airflow at the wet clothes (See Fig.A).
- For thick and heavy wet clothes may not get the best effective dehumidification.

CAUTION

- Do not cover the air outlet of the unit with clothes. It may cause excessive heat, fire or failure of unit.
- Do not place the wet clothes on the top of the unit and do not make the water drop into the unit. It may cause electric shock, creepage or failure of unit.

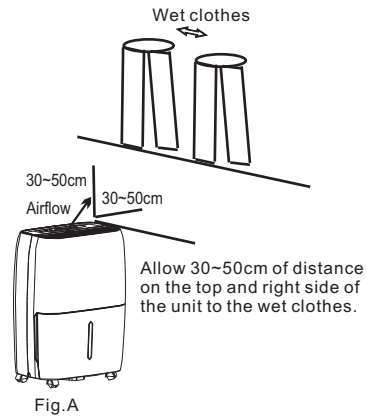

Identification of parts

Front

- 1 Control panel
- 2 Handle
- 3 Air outlet grille
- 4 Water bucket
- 5 Water level window

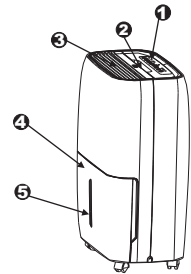

Rear

- 1 Drain hose outlet
- 2 Caster
- 3 Power Cord and plug
- 4 Air intake grille
- 5 Air filter (behind the grill)

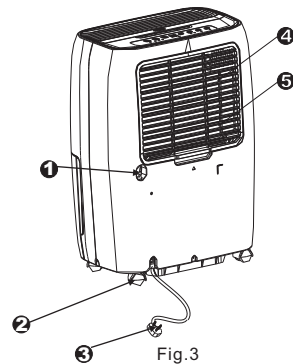

OPERATING THE UNIT

Positioning the unit

A dehumidifier operating in a basement will have little or no effect in drying an adjacent enclosed storage area, such as a closet, unless there is adequate circulation of air in and out of the area.

- Do not use outdoors.
- This dehumidifier is intended for indoor residential applications only. This dehumidifier should not be used for commercial or industrial applications.
- Place the dehumidifier on a smooth, level floor strong enough to support the unit with a full bucket of water.
- Allow at least 20cm of air space on all sides of the unit for good air circulation.
- Place the unit in an area where the temperature will not fall below 5°C(41°F). The coils can become covered with frost at temperatures below 5°C(41°F), which may reduce performance.
- Place the unit away from the clothes dryer, heater or radiator.
- Use the unit to prevent moisture damage anywhere books or valuables are stored.
- Use the dehumidifier in a basement to help prevent moisture damage.
- The dehumidifier must be operated in an enclosed area to be most effective.
- Close all doors, windows and other outside openings to the room.

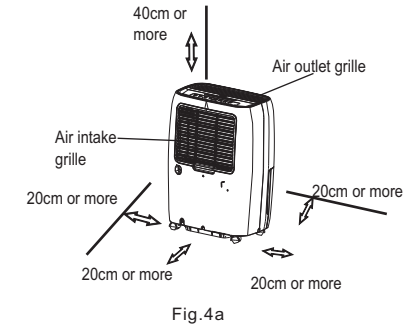

Casters(At four points on the bottom of unit)

- Casters can move freely.
- Do not force casters to move over carpet, nor move the unit with water in the bucket. (The unit may tip over and spill water.)

When using the unit

- When first using the dehumidifier, operate the unit continuously 24 hours.
- This unit is designed to operate with a working environment between 5°C/41°F and 35°C/95°F.
- After turning on several minutes, the compressor may operate with higher noise. It is a normal phenomenon.
- If the unit has been switched off and needs to be switched on again quickly, allow approximately three minutes for the correct operation to resume.
- Do not connect the dehumidifier to a multiple socket outlet, which is also being used for other electrical appliances.
- Select a suitable location, making sure you have easy access to an electrical outlet.
- Plug the unit into a electrical socket-outlet with earth connection.
- Make sure the Water bucket is correctly fitted otherwise the unit will not operate properly.

NOTE:When the water in the bucket reaches to a certain level, please be careful to move the machine to avoid it falling down.

OPERATING THE UNIT

Removing the collected water

There are two ways to remove collected water.

1. Use the bucket

- When the unit is off, if the bucket is full, the unit will beep 8 times and the Full indicator light will flash, the digital display shows P2.
- When the unit is on, if the bucket is full, the compressor turns off and the fan turns off after 30 seconds for drying the water of the condenser, then the unit will beep 8 times and the Full indicator light will flash, the digital display shows P2.
- Slowly pull out the bucket. Grip the left and right handles securely, and carefully pull out straight so water does not spill. Do not put the tank on the floor because the bottom of the bucket is uneven. Otherwise the bucket will fall and cause the water to spill.
- Throw away the water and replace the bucket. The bucket must be in place and securely seated for the dehumidifier to operate.
- The machine will re-start when the bucket is restored in its correct position.

NOTES:

- When you remove the bucket, do not touch any parts inside of the unit. Doing so may damage the product.
- Be sure to push the bucket gently all the way into the unit. Banging the bucket against anything or failing to push it in securely may cause the unit not to operate.
- When you remove the bucket, if there is some water in the unit you must dry it.

2. Continuous draining

Water can be automatically emptied into a floor drain by attaching the unit with a water hose (not included).

- Remove the rubber plug from the back drain hose outlet. Attach a drain hose (ID=13.5mm) and lead it to the floor drain or a suitable drainage facility (see Fig.7).
- Make sure the hose is secure so there are no leaks.
- Direct the hose toward the drain, making sure that there are no kinks that will stop the water flowing.
- Place the end of the hose into the drain and make sure the end of the hose is level or down to let the water flow smoothly. Do never let it up.
- Select the desired humidity setting and fan speed on the unit for continuous draining to start.

NOTE: When the continuous drain feature is not being used, remove the drain hose from the outlet.

1. Pull out the bucket a little.

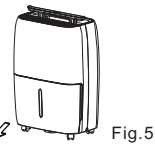

2. Hold both sides of the bucket with even strength, and pull it out from the unit.

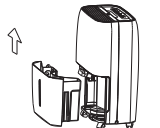

3. Pour the water out.

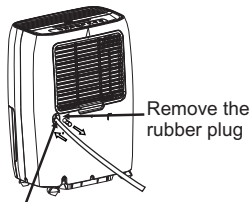

Attach the hose to the drain hose outlet.

Fig.7

CARE AND MAINTENANCE

Care and cleaning of the dehumidifier

Turn the dehumidifier off and remove the plug from the wall outlet before cleaning.

1. Clean the Grille and Case

- Use water and a mild detergent. Do not use bleach or abrasives.
- Do not splash water directly onto the main unit. Doing so may cause an electrical shock, cause the insulation to deteriorate, or cause the unit to rust.
- The air intake and outlet grilles get soiled easily, so use a vacuum attachment or brush to clean.

2. Clean the bucket

Every few weeks, clean the bucket to prevent growth of mold, mildew and bacteria. Partially fill the bucket with clean water and add a little mild detergent. Swish it around in the bucket, empty and rinse.

NOTE: Do not use a dishwasher to clean the bucket. After clean, the bucket must be in place and securely seated for the dehumidifier to operate.

3. Clean the air filter

The air filter behind the front grille should be checked and cleaned at least every 30 days or more often if necessary.

NOTE: DO NOT RINSE OR PUT THE FILTER IN AN AUTOMATIC DISHWASHER.

To remove:

- Grip the tab on the filter and pull it upward, then pull it out as shown in Fig. 8 and Fig.9.
- Clean the filter with warm, soapy water. Rinse and let the filter dry before replacing it. Do not clean the filter in a dishwasher.

To attach:

- Insert the air filter into the unit from underside to upside. See Fig.10.

CAUTION:

DO NOT operate the dehumidifier without a filter because dirt and lint will clog it and reduce performance.

4. When not using the unit for long time periods

- After turning off the unit, wait one day before emptying the bucket.
- Clean the main unit, water bucket and air filter.
- Cover the unit with a plastic bag.
- Store the unit upright in a dry, well-ventilated place.

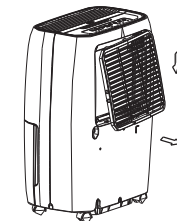

Fig. 8



Fig. 9

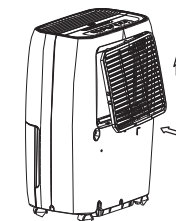

Fig. 10

TROUBLESHOOTING TIPS

Before calling for service, review the chart below first yourself.

Problem	What to check
Unit does not start	<ul style="list-style-type: none">● Make sure the dehumidifier's plug is pushed completely into the outlet.● Check the house fuse/circuit breaker box.● Dehumidifier has reached its preset level or bucket is full.● Water bucket is not in the proper position.
Dehumidifier does not dry the air as it should	<ul style="list-style-type: none">● Did not allow enough time to remove the moisture.● Make sure there are no curtains, blinds or furniture blocking the front or back of the dehumidifier.● The humidity control may not be set low enough.● Check that all doors, windows and other openings are securely closed.● Room temperature is too low, below 5°C(41°F).● There is a kerosene heater or something giving off water vapor in the room.
The unit makes a loud noise when operating	<ul style="list-style-type: none">● The air filter is clogged.● The unit is tilted instead of upright as it should be.● The floor surface is not level.
Frost appears on the coils	<ul style="list-style-type: none">● This is normal. The dehumidifier has Auto defrost feature.
Water on floor	<ul style="list-style-type: none">● Hose to connector or hose connection may be loose.● Intend to use the bucket to collect water, but the back drain plug is removed.
ES, AS, E1,E3,P1 or P2 appear in the display	<ul style="list-style-type: none">● These are error codes and protection codes. See the CONTROL PADS ON THE DEHUMIDIFIER section.