



United Technologies

PRODUCT SELECTION DATA



- Slim design
- Acoustic comfort
- 40% smaller footprint

Drycoolers

09VE



CARRIER participates in the ECP programme for LCP/HP
Check ongoing validity of certificate:
www.eurovent-certification.com
www.certiflash.com



09VE

Use

Drycoolers in this range are mainly designed for cooling water or glycol/water mix for:

- Condensers for water chillers,
- Free cooling.

These devices are designed to be installed outdoors.

Range

- More than 220 models.
- A range of sizes, from 6 to 20 fans.
- 2 impeller diameters, 800 or 910 mm.
- Several rotation speeds, from 300 to 1 270 rpm.

Various combinations of these elements, as well as the choice of a number of options, allow us to provide devices that are adapted to a wide range of applications and environments.

Description

Excellent resistance to corrosion

The casing boasts category C3 protection against corrosion, in line with ISO standard 12944-2.

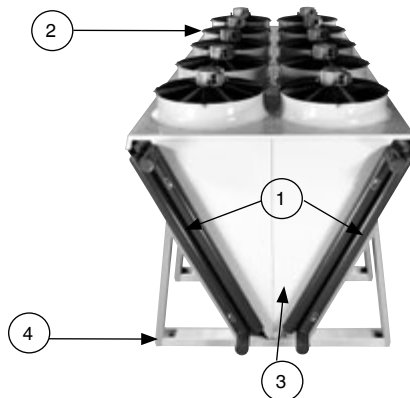

① 2 Coils

Copper tubes and high-performance aluminium fins, resistant to fouling.
Manifolds and piping: steel painted with graphite grey RAL 7024.

② Fan motor assemblies

Galvanised steel profiled collars with polyester powder coating (light grey RAL 7035 paint) or composite collar (black RAL 9005) for 1270/980 rpm motor.

Aluminium + polypropylene propeller.

Class F motors - IP54 - TRI400V +/-10% 50Hz+/-2% - Standard connection to motor terminal boxes.

Black protective grille compliant with standard BS ISO 12499.

The motors are also available in a 60 Hz version or in other voltages.

③ Casing

Galvanised steel with polyester powder coating (light grey RAL 7035 paint).

④ Feet

Galvanised steel with polyester powder coating (light grey RAL 7035 paint).

Each device is tested:

- The air tightness of the coil is subjected to an underwater airtightness test.
- For devices with the terminal box or electrical cabinet option: rotation tests, dielectric tests, current measurement.

The range complies with the following European directives:

- Machinery Directive 2006/42/EC,
- EMC Directive 2014/30/UE,
- Pressure Equipment Directive (PED) 2014/68/UE.

Designation

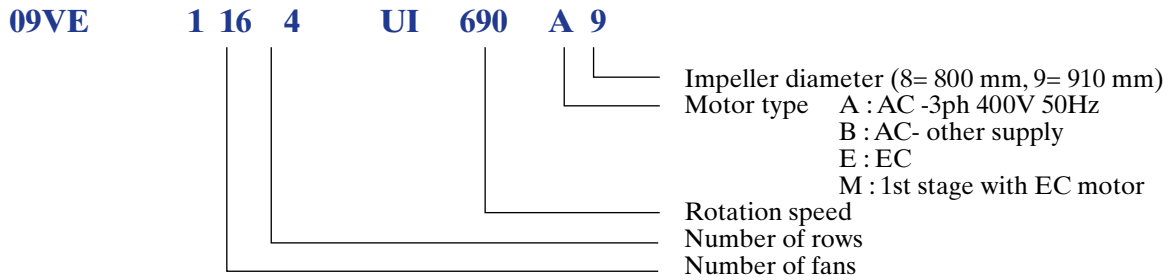

Options for each application

	Options	Description/Assets
Protection adapted for the environment	Pre-coated aluminium fins	Improves the resistance of the blades to corrosion. For low corrosion environments.
	High efficiency coating on fins: ALUCOAT®507 or HERESITE	Improves the resistance of the blades to corrosion. For relatively corrosive environments.
	Stainless steel tubing bundle	For corrosive fluids.
	Corrosiveness resistance category C5M	Casing and fan motor assemblies for corrosive environments.
Quick and simple installation	Terminal box	Connection to the terminals of each motor on the front panel of the device.
	Protection cabinet	Protected by a thermal-magnetic circuit breaker on each motor.
	Control cabinet with DRY-PIC	Protection motors and control by electronic board depending on temperature
	Flanges	NFE 1092-1 type 01A PN16 steel
	Counter-flanges	In steel, with gaskets and bolts.
	Blade protective screen	Impact protection.
Optimisation of electrical consumption and noise	EC (electrically commutated) motor	Variable speed control from 0 to 100% using a 0/10V signal. With the control cabinet via electronic board option, the device is self-regulating.
Application for water without glycol	Drainable coil	Device located on a slope to prevent frost - Drainage by gravity
Free cooling application	Free cooling valve kit	Valves with motor, controlled by the electronic board. Controlled according to the operation of the drycooler or chiller.
Adiabatic cooling application	ADIABATIC COOLER (water misting into the air flow)	Size of the unit reduced by cooling of the ambient air. Operates completely safely due to the antibacterial treatment applied to the water.

Electrical specifications

I : maximum input current









P : maximum power input







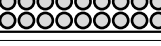

The currents and power actually absorbed depend on the operation point and will be indicated in detail when the unit is selected.

		AC MOTORS (A9)								EC MOTOR (E9)	
		Impeller Ø 910 mm								Impeller Ø 910 mm	
		1270		980		900		690		1000	
Speed	Wiring	Δ		Y		Δ		Y			
		I (A)	P(kW)	I (A)	P(kW)	I (A)	P(kW)	I (A)	P(kW)	I (A)	P(kW)
1060		46,80	27,60	28,80	17,40	31,80	15,90	18,00	11,04	26,40	17,88
1080		62,40	36,80	38,40	23,20	42,40	21,20	24,00	14,72	35,20	23,84
1100		78,00	46,00	48,00	29,00	53,00	26,50	30,00	18,40	44,00	29,80
1120		93,60	55,20	57,60	34,80	63,60	31,80	36,00	22,08	52,80	35,76
1140		109,20	64,40	67,20	40,60	74,20	37,10	42,00	25,76	61,60	41,72
1160		124,80	73,60	76,80	46,40	84,80	42,40	48,00	29,44	70,40	47,68
1180		140,40	82,80	86,40	52,20	95,40	47,70	54,00	33,12	79,20	53,64
1200		156,00	92,00	96,00	58,00	106,00	53,00	60,00	36,80	88,00	59,60

		AC MOTORS (A8)										EC MOTOR (E8)					
		Impeller Ø 800 mm										Impeller Ø 800 mm					
		900		700		690		560		425		300		510 (E8B)		740 (E8A)	
Speed	Wiring	Δ		Y		Δ		Y		Δ		Y					
		I (A)	P(kW)	I (A)	P(kW)	I (A)	P(kW)	I (A)	P(kW)	I (A)	P(kW)	I (A)	P(kW)	I (A)	P(kW)	I (A)	P(kW)
1060		21,9	11,88	14,4	8,58	12,6	5,37	6,3	3,36	2,52	1,16	2,1	0,45	2,94	1,78	8,4	5,5
1080		29,2	15,84	19,2	11,44	16,8	7,16	8,4	4,48	3,36	1,55	2,8	0,6	3,92	2,38	11,2	7,34
1100		36,5	19,8	24	14,3	21	8,95	10,5	5,6	4,2	1,94	3,5	0,75	4,9	2,98	14	9,18
1120		43,8	23,76	28,8	17,16	25,2	10,74	12,6	6,72	5,04	2,32	4,2	0,9	5,88	3,57	16,8	11,01
1140		51,1	27,72	33,6	20,02	29,4	12,53	14,7	7,84	5,88	2,71	4,9	1,05	6,86	4,17	19,6	12,85
1160		58,4	31,68	38,4	22,88	33,6	14,32	16,8	8,96	6,72	3,1	5,6	1,2	7,84	4,76	22,4	14,68
1180		65,7	35,64	43,2	25,74	37,8	16,11	18,9	10,08	7,56	3,49	6,3	1,35	8,82	5,36	25,2	16,52
1200		73	39,6	48	28,6	42	17,9	21	11,2	8,4	3,88	7	1,5	9,8	5,96	28	18,36

Sound levels

		SOUND PRESSURE LEVEL (Lp) * / SOUND POWER LEVEL (Lw)** - dB(A)									
		AC MOTORS (A9)								EC MOTOR (E9)	
		Impeller Ø 910 mm								Impeller Ø 910 mm	
Speed	Wiring	1270		980		900		690		1000	
		Δ		Y		Δ		Y			
		Lp	Lw	Lp	Lw	Lp	Lw	Lp	Lw	Lp	Lw
1060		70,2	102,4	61,7	93,9	62,7	94,9	55,8	88	64,1	96,3
1080		71,3	103,6	62,8	95,1	63,8	96,1	56,9	89,2	65,2	97,5
1100		72,1	104,6	63,6	96,1	64,6	97,1	57,7	90,2	66	98,5
1120		72,8	105,4	64,3	96,9	65,3	97,9	58,4	91	66,7	99,3
1140		73,3	106,1	64,8	97,6	65,8	98,6	58,9	91,7	67,2	100
1160		73,8	106,6	65,3	98,1	66,3	99,1	59,4	92,2	67,7	100,5
1180		74,1	107,2	65,6	98,7	66,6	99,7	59,7	92,8	68	101,1
1200		74,5	107,6	66	99,1	67	100,1	60,1	93,2	68,4	101,5

		SOUND PRESSURE LEVEL (Lp) * / SOUND POWER LEVEL (Lw)** - dB(A)															
		AC MOTORS (A8)								EC MOTOR (E8)							
		Impeller Ø 800 mm								Impeller Ø 800 mm							
Speed	Wiring	900		700		690		560		425		300		510 (E8B)		740 (E8A)	
		Δ		Y		Δ		Y		Δ		Y					
		Lp	Lw	Lp	Lw	Lp	Lw	Lp	Lw	Lp	Lw	Lp	Lw	Lp	Lw	Lp	Lw
1060		57	89,2	49,8	82	52,1	84,3	47	79,2	35,8	68	27,1	59,3	41,5	73,7	50,1	82,3
1080		58,1	90,4	50,9	83,2	53,2	85,5	48,1	80,4	36,9	69,2	28,2	60,5	42,6	74,9	51,2	83,5
1100		58,9	91,4	51,7	84,2	54	86,5	48,9	81,4	37,7	70,2	29	61,5	43,4	75,9	52	84,5
1120		59,6	92,2	52,4	85	54,7	87,3	49,6	82,2	38,4	71	29,7	62,3	44,1	76,7	52,7	85,3
1140		60,1	92,9	52,9	85,7	55,2	88	50,1	82,9	38,9	71,7	30,2	63	44,6	77,4	53,2	86
1160		60,6	93,4	53,4	86,2	55,7	88,5	50,6	83,4	39,4	72,2	30,7	63,5	45,1	77,9	53,7	86,5
1180		60,9	94	53,7	86,8	56	89,1	50,9	84	39,7	72,8	31	64,1	45,4	78,5	54	87,1
1200		61,3	94,4	54,1	87,2	56,4	89,5	51,3	84,4	40,1	73,2	31,4	64,5	45,8	78,9	54,4	87,5

* Values measured at 10 m for horizontal units in free field, directivity 2, in line with the coil. Tolerance ±3dB.

** Only the sound power level is characteristic of the unit. These values are obtained in compliance with the ISO 3744 standard.

The difference between the sound power level and pressure level varies according to the site. To determine the unit's sound pressure level, recalculate it using the sound power level of the unit and the site conditions (you may need to consult an acoustical engineer).

As the sound emitted by the unit is not uniform in all directions, for a point 10 m away in line with the fans, the recalculated pressure value must be increased by approximately 4 dB.

Dimensions

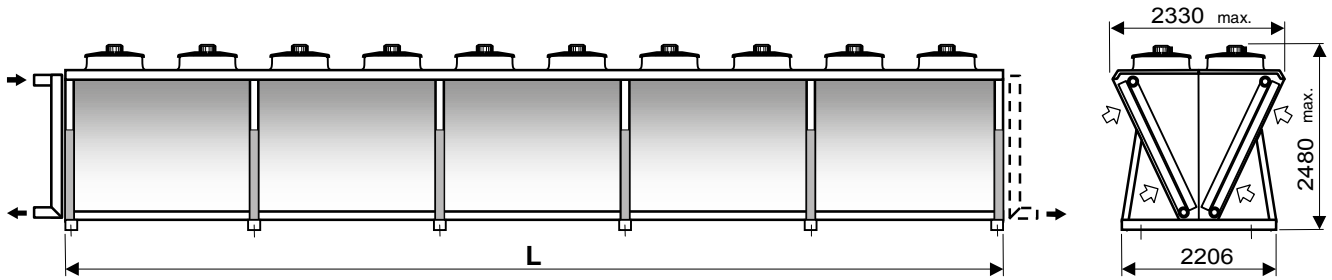

	1060	1080	1100	1120	1140	1160	1180	1200
L (mm)	3550	4700	5850	7000	8150	9300	10450	11660

Up to size 1180, these units can be transported by container.

Installation recommendations

- These units are designed to operate outside.
 When starting up, frost and snow could adversely impair its operation.
 As a general measure, all steps should be taken to avoid the risk of air recycling. This is especially important when the installation comprises several units.
 It is not recommended to install units near the hot air extraction duct outlet or close to deciduous plants (this could cause clogging).
- Allow a clearance of 1.5 m around the device. Where the use of antivibration mounts is required, use a rigid frame which locks the feet together.
- If **speed regulators** other than those recommended by the manufacturer are used, check that these are compatible with the electric motors.
- **Commissioning and maintenance:** refer to the instruction manual.
- These units **comply with the European directives**. The installer is responsible for ensuring the compliance of the installation. The installer must ensure safety and protective devices (emergency stop, shut-off valves, lightning protection, etc.) are put in place and are accessible.



Order No.: 10033, 02.2017 - Supersedes order No.: 10033, 11.2015.
The manufacturer reserves the right to change any product specifications without notice.



www.eurovent-certification.com
www.certiflash.com



Quality and Environment
Management Systems
Approval

Manufactured for Carrier in France.
Printed in the European Union.